

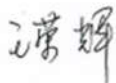

APPROVAL SHEET

Document No	MT-E-PS-Q0407
Product Name	40Gbps QSFP+ AOC
Product Model	MQXLD2-DZC-XXXT
Version	A0
Issue Date	2017-07-28

Designed By	Inspected By	Approved By
		

MQXLD2-DZC-XXXT

Features

- ◆ Four-channel full-duplex active optical cable
- ◆ Complies with QSFP MSA high-density form factor
- ◆ Reliable VCSEL array technology using multimode fiber
- ◆ Hot Pluggable
- ◆ Flat, rubberized, LSZH cable
- ◆ Low power dissipation: <1.3W per cable end
- ◆ Commercial operating case temperature range: 0°C to 70°C
- ◆ RoHS-6 Compliant

Application

- ◆ Infiniband QDR
- ◆ 40G Ethernet
- ◆ 4G/8G/10G Fiber Channel
- ◆ HPC Interconnections

General Description

This product is a high data rate parallel active optical cable (AOC), to overcome the bandwidth limitation of traditional copper cable. The AOC offers 4 independent data transmission channels and 4 data receiving channels via the multimode ribbon fibers, each capable of 10 Gb/s operation. Consequently, an aggregate data rate of 40Gb/s over 100 meters transmission can be achieved by this product, to support the ultra-fast computing data exchange.

The product is designed with form factor, optical/electrical connection according to the QSFP+ Multi-Source Agreement (MSA). It has been designed to meet the harshest external operating conditions including temperature, humidity and EMI interference.

Specification:

Absolute Maximum Ratings				
Parameter	Symbol	Min	Max	Unit
Storage Ambient Temperature	T _{STG}	-40	85	°C
Operating Case Temperature	T _c	0	70	°C
Operating Humidity	H _o	5	85	%
Power Supply Voltage	V _{cc}	0	+3.6	V

Recommended Operating Conditions					
Parameter	Symbol	Min	Typical	Max	Unit
Power Supply Voltage	V _{cc}	3.135	3.3	3.465	V
Data Rate,each Lane			10.3125	11.2	Gbps
Control Input Voltage High		2		V _{CC}	V
Control Input Voltage Low		0		0.8	V

The following electrical characteristics are defined over the Recommended Operating temperature and supply voltage unless otherwise specified.						
Parameter	Symbol	Min	Typical	Max	Unit	Notes
Power Consumption, each Terminal				1.5	W	
Supply Current, each Terminal	I _{cc}			450	mA	
Transceiver Power-on Initialization Time				2000	ms	

Transmitter (each Lane)						
Parameter	Symbol	Min	Typical	Max	Unit	Notes
Single Ended Input Voltage Tolerance		-0.3		4	V	
AC Common Mode Input Voltage Tolerance		15			mV	RMS
Differential Input Voltage Swing Threshold		50			mV _{pp}	LOSA Threshold
Differential Input Voltage Swing	V _{in,pp}	180		1200	mV _{pp}	
Differential Input Impedance	Z _{in}	90	100	110	Ohm	
Single Ended Input Voltage Tolerance		-0.3		4	V	

Differential Input S-parameter	SDD11	$< -12 + 2 \times \text{SQRT}(f)$, with f in GHz.			dB	0.01-4.1GHz
		$< -6.3 + 13 \times \log_{10}(f/5.5)$, with f in GHz			dB	4.1-11.1GHz
Reflected Differential to Common Mode Conversion	SCD11			-10	dB	0.01-11.1GHz
Total Jitter				0.40	UI	
Deterministic Jitter				0.15	UI	

Receiver (each Lane)						
Parameter	Symbol	Min	Typical	Max	Unit	Notes
Single Ended Output Voltage		-0.3		4	V	
AC Common Mode Output Voltage				7.5	mV	RMS
Differential Output Voltage Swing	Vout,pp	600		800	mVpp	
Differential Output Impedance	Zout	90	100	110	Ohm	
Differential Output S-parameter	SDD22	$< -12 + 2 \times \text{SQRT}(f)$, with f in GHz			dB	0.01-4.1GHz
		$< -6.3 + 13 \times \log_{10}(f/5.5)$, with f in GHz			dB	4.1-11.1GHz
Common Mode Output Reflection Coefficient	SCC22	$< -7 + 1.6 \times f$, with f in GHz			dB	0.01-2.5GHz
				-3	dB	2.5-11.1GHz
Total Jitter				0.38	UI	
Deterministic Jitter				0.64	UI	

Pin Definition

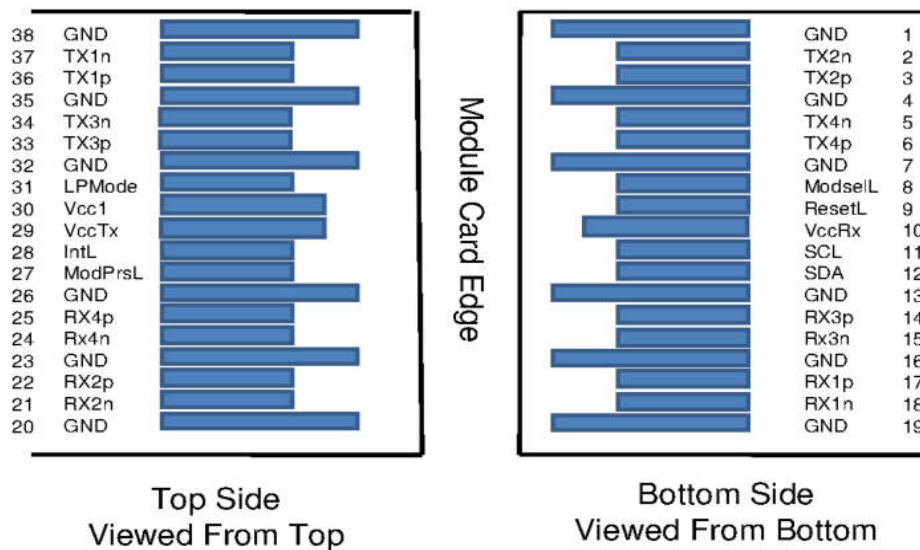

Figure1 QSFP MSA-compliant 38-pin connector

Pin	Symbol	Name/Description	Power Seq.	Ref.
1	GND	Ground	1	
2	TX2N	Transmitter Inverted Data Input		
3	TX2P	Transmitter Non-Inverted Data Input		
4	GND	Ground	1	
5	TX4N	Transmitter Inverted Data Input		
6	TX4P	Transmitter Non-Inverted Data Input		
7	GND	Ground	1	
8	ModSelL	Module Select		
9	ResetL	Module Reset		
10	Vcc Rx	+3.3 V Power supply receiver	2	
11	SCL	2-wire serial interface clock		
12	SDA	2-wire serial interface data		
13	GND	Ground	1	
14	RX3P	Transmitter Inverted Data Input		
15	RX3N	Transmitter Non-Inverted Data Input		
16	GND	Ground	1	
17	RX1P	Transmitter Inverted Data Input		
18	RX1N	Transmitter Non-Inverted Data Input		
19	GND	Ground	1	
20	GND	Ground	1	

21	RX2N	Transmitter Inverted Data Input		
22	RX2P	Transmitter Non-Inverted Data Input		
23	GND	Ground	1	
24	RX4N	Transmitter Inverted Data Input		
25	RX4P	Transmitter Non-Inverted Data Input		
26	GND	Ground	1	
27	ModPrsL	Module Present		
28	IntL	Interrupt		
29	VccTx	+3.3 V Power supply transmitter	2	
30	Vcc1	+3.3 V Power Supply	2	
31	LPMODE	Low Power Mode		
32	GND	Ground	1	
33	TX3P	Transmitter Inverted Data Input		
34	TX3N	Transmitter Non-Inverted Data Input		
35	GND	Ground	1	
36	TX1P	Transmitter Inverted Data Input		
37	TX1N	Transmitter Non-Inverted Data Input		
38	GND	Ground	1	

Table 1: QSFP Module PIN Definition

Power Seq.:

1. GND is the symbol for signal and supply (power) common for QSFP+ modules. All are common within the QSFP+ module and all module voltages are referenced to this potential unless otherwise noted. Connect these directly to the host board signal common ground plane.
2. VccRx, Vcc1 and VccTx are the receiving and transmission power suppliers and shall be applied concurrently. Recommended host board power supply filtering is shown in Figure 3 below. Vcc Rx, Vcc1 and VccTx may be internally connected within the QSFP+ transceiver module in any combination. The connector pins are each rated for a maximum current of 500mA.

Recommended Power Supply Filter

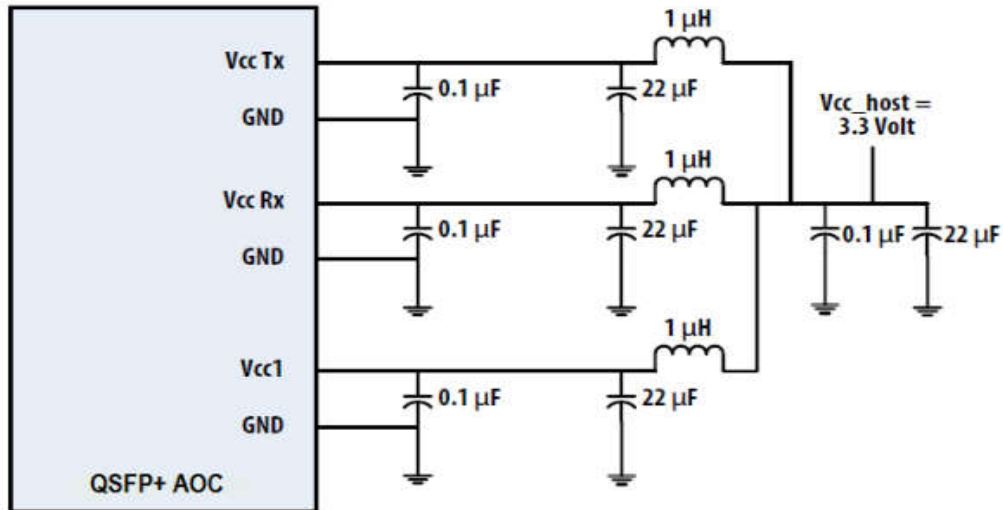
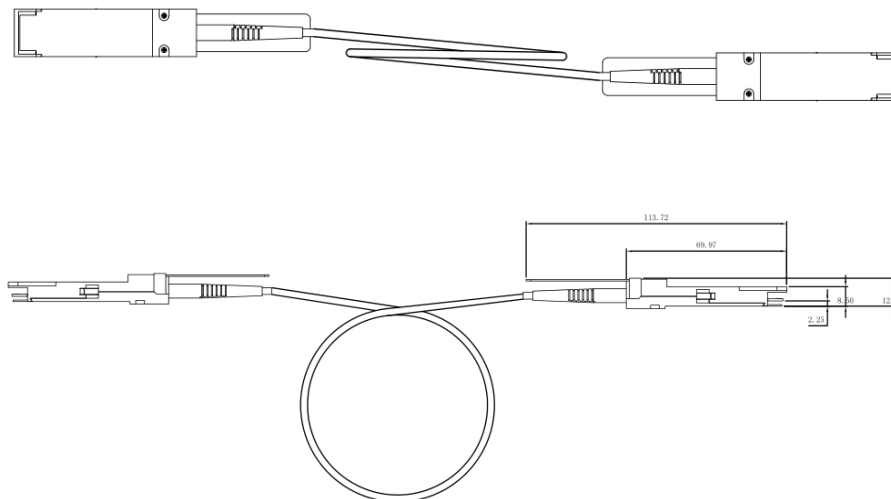

Figure2 Recommended Power Supply Filter

Package Outline

Dimensions are in millimeters. All dimensions are ± 0.1 mm unless otherwise specified.

(unit: mm)



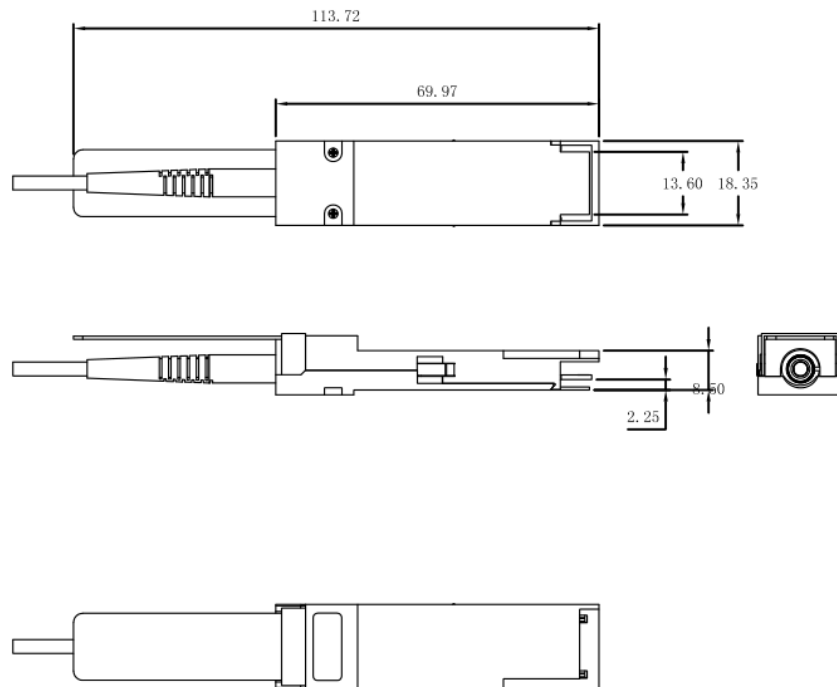

Ordering information

Part. No	Specifications						
	Pack	Rate (Gbps)	Tx (nm)	Rx	Temp (°C)	Reach (m)	Others
MQXLD2-DZC-001T	QSFP+	40	850 VCSEL	PIN	0~+70	1	RoHS
MQXLD2-DZC-003T	QSFP+	40	850 VCSEL	PIN	0~+70	3	RoHS
MQXLD2-DZC-005T	QSFP+	40	850 VCSEL	PIN	0~+70	5	RoHS
MQXLD2-DZC-007T	QSFP+	40	850 VCSEL	PIN	0~+70	7	RoHS
MQXLD2-DZC-010T	QSFP+	40	850 VCSEL	PIN	0~+70	10	RoHS
MQXLD2-DZC-015T	QSFP+	40	850 VCSEL	PIN	0~+70	15	RoHS
MQXLD2-DZC-020T	QSFP+	40	850 VCSEL	PIN	0~+70	20	RoHS
MQXLD2-DZC-025T	QSFP+	40	850 VCSEL	PIN	0~+70	25	RoHS
MQXLD2-DZC-030T	QSFP+	40	850 VCSEL	PIN	0~+70	30	RoHS
MQXLD2-DZC-040T	QSFP+	40	850 VCSEL	PIN	0~+70	40	RoHS
MQXLD2-DZC-050T	QSFP+	40	850 VCSEL	PIN	0~+70	50	RoHS

*Note:

1. OM3 Cable length =<300m
2. More detail product selection and cable lengths, please contact MNC